

## NPN General Purpose Transistor

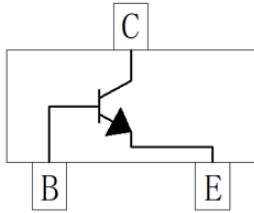

SOT-23

### Features

- Epoxy meets UL-94 V-0 flammability rating and halogen free
- Moisture Sensitivity Level 1
- Part no. with suffix "Q" means AEC-Q101 qualified

### Applications

- Linear amplification

### Mechanical Data

- **Case:** SOT-23
- **Terminals:** Tin plated leads, solderable per J-STD-002 and JESD22-B102
- **Marking:**

S8050-LQ	J3Y·L
S8050-HQ	J3Y

### ■ Maximum Ratings (Ta=25°C unless otherwise noted)

Item	Symbol	Unit	Conditions	Value
Collector-Base Voltage	$V_{CBO}$	V		40
Collector-Emitter Voltage	$V_{CEO}$	V		25
Emitter-Base Voltage	$V_{EBO}$	V		5
Collector Current -Continuous	$I_C$	mA		500
Total Device Dissipation	$P_D$	mW		300
Thermal Resistance From Junction To Ambient	$R_{\theta JA}$	°C/W		417
Maximum Junction Temperature	$T_j$	°C		150
Storage Temperature	$T_{STG}$	°C		-55 to +150

### ■ Electrical Characteristics (Ta=25°C unless otherwise noted)

Item	Symbol	Unit	Conditions	Min	Max
Collector-base breakdown voltage	$V_{(BR)CBO}$	V	$I_C=100\mu A, I_E=0$	40	
Collector-emitter breakdown voltage	$V_{(BR)CEO}$	V	$I_C=100\mu A, I_B=0$	25	
Emitter-base breakdown voltage	$V_{(BR)EBO}$	V	$I_E=100\mu A, I_C=0$	5	
Collector cut-off current	$I_{CBO}$	nA	$V_{CB}=40V, I_E=0$		100
Collector cut-off current	$I_{CEO}$	nA	$V_{CE}=20V, I_B=0$		100
Emitter cut-off current	$I_{EBO}$	nA	$V_{EB}=5V, I_C=0$		100
DC current gain	$h_{FE(1)}$		$V_{CE}=1.0V, I_C=50mA$	120	350
	$h_{FE(2)}$		$V_{CE}=1.0V, I_C=500mA$	50	



# S8050-LQ THRU S8050-HQ

Collector-emitter saturation voltage	$V_{CE(sat)}$	V	$I_C=500mA, I_B=50mA$	0.6
Base-emitter saturation voltage	$V_{BE(sat)}$	V	$I_C=500mA, I_B=50mA$	1.2

## Small-signal Characteristics

Item	Symbol	Unit	Conditions	Min	Max
Transition frequency	$f_T$	MHz	$V_{CE}=6V_{dc}, I_C=20mA, f=30MHz$	150	

## Classification Of $h_{FE}$ (1)

Rank	L	H
Range	120-200	200-350

## Ordering Information (Example)

PREFERRED P/N	PACKING CODE	UNIT WEIGHT(g)	MINIMUM PACKAGE(pcs)	INNER BOX QUANTITY(pcs)	OUTER CARTON QUANTITY(pcs)	DELIVERY MODE
S8050-LQ THRU S8050-HQ	F2	Approximate 0.01	3000	30000	120000	7" reel

## Characteristics (Typical)

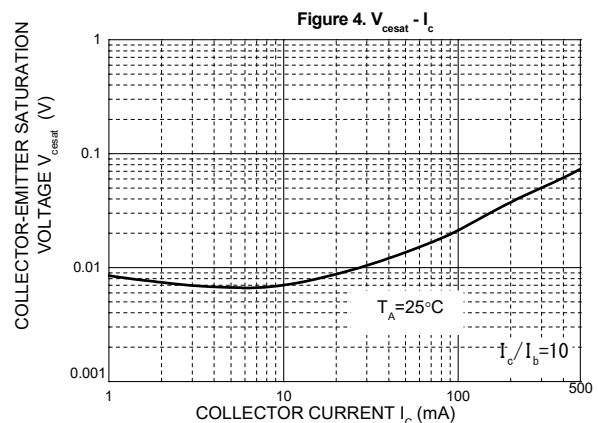
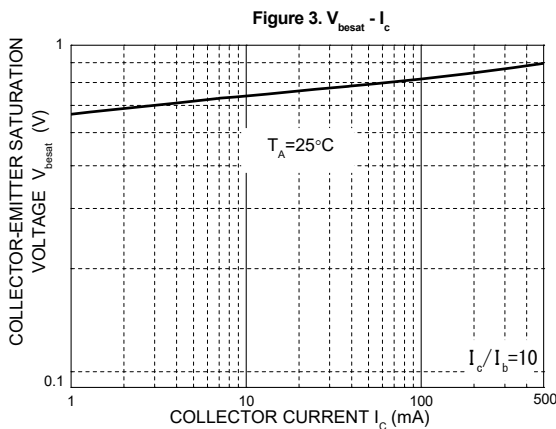
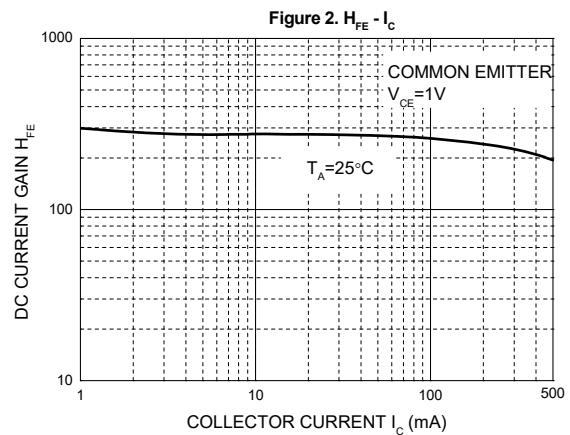
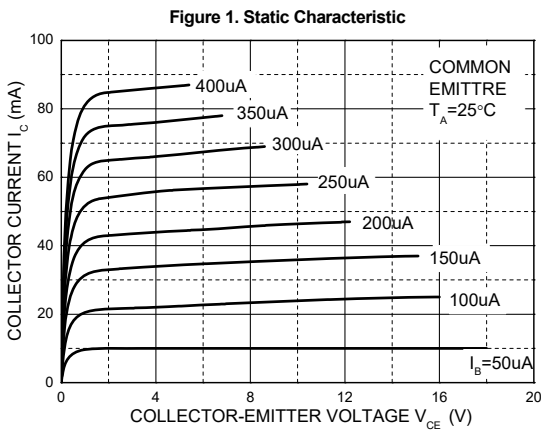



# S8050-LQ THRU S8050-HQ

## ■SOT-23 Package Outline Dimensions

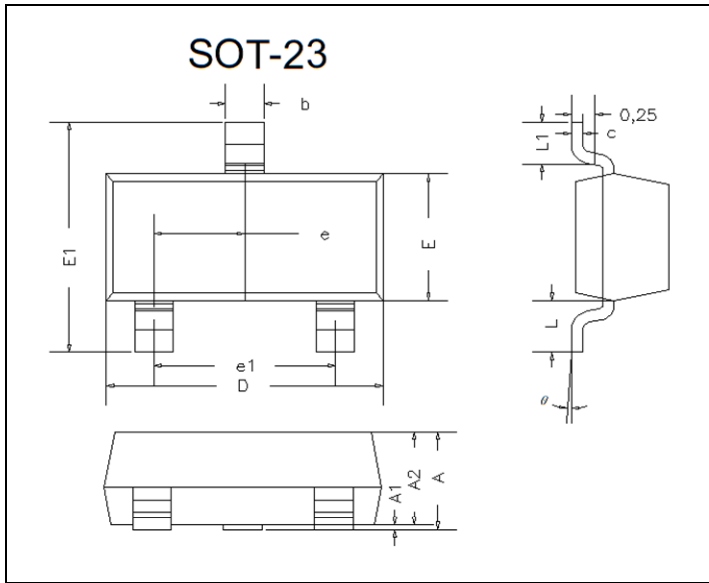

DIM	INCHES		MM		NOTE
	MIN	MAX	MIN	MAX	
A	0.035	0.045	0.90	1.15	
A1	0.000	0.004	0.00	0.10	
A2	0.035	0.041	0.90	1.05	
b	0.012	0.020	0.30	0.50	
c	0.004	0.008	0.10	0.20	
D	0.110	0.118	2.80	3.00	
E	0.047	0.055	1.20	1.40	
E1	0.089	0.100	2.25	2.55	
e	0.370TYP		0.95TYP		
e1	0.071	0.079	1.80	2.00	
L	0.220REF		0.55REF		
L1	0.012	0.020	0.30	0.50	
θ	0°	8°	0°	8°	

## ■SOT-23 Suggested Pad Layout

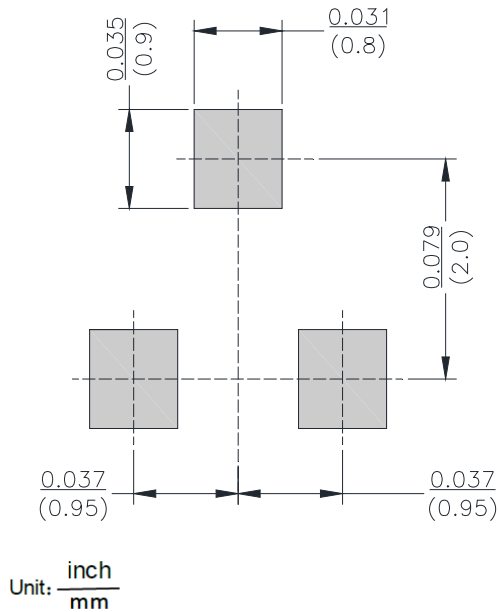



## S8050-LQ THRU S8050-HQ

---

### Disclaimer

The information presented in this document is for reference only. Yangzhou Yangjie Electronic Technology Co., Ltd. reserves the right to make changes without notice for the specification of the products displayed herein to improve reliability, function or design or otherwise.

The product listed herein is designed to be used with automotive electronics, are not designed for use in medical, life-saving, lifesustaining, or military. Yangjie or anyone on its behalf, assumes no responsibility or liability for any damages resulting from such improper use of sale.

This publication supersedes & replaces all information previously supplied. For additional information, please visit our website [http:// www.21yangjie.com](http://www.21yangjie.com) , or consult your nearest Yangjie's sales office for further assistance.